

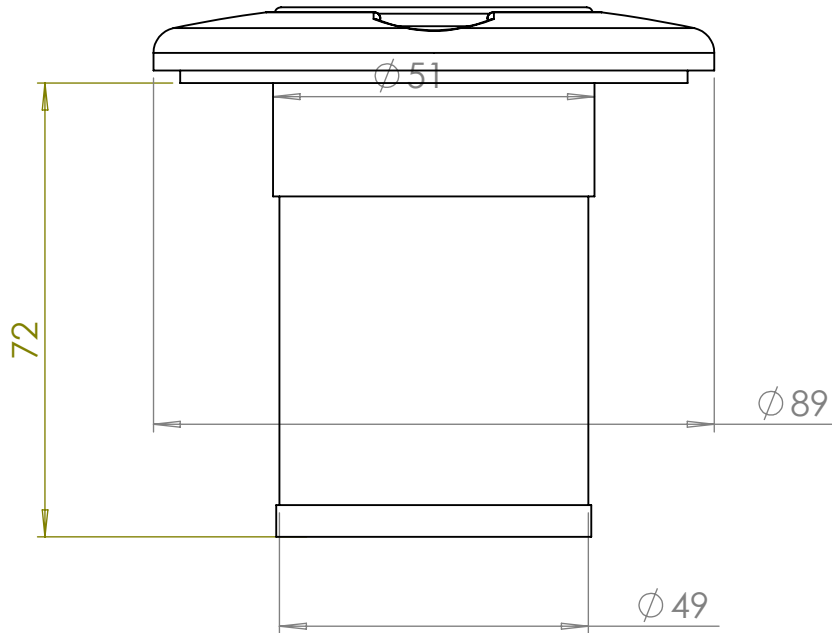

$\phi 4.3$
 3 OFF
 ON 67mm PCD

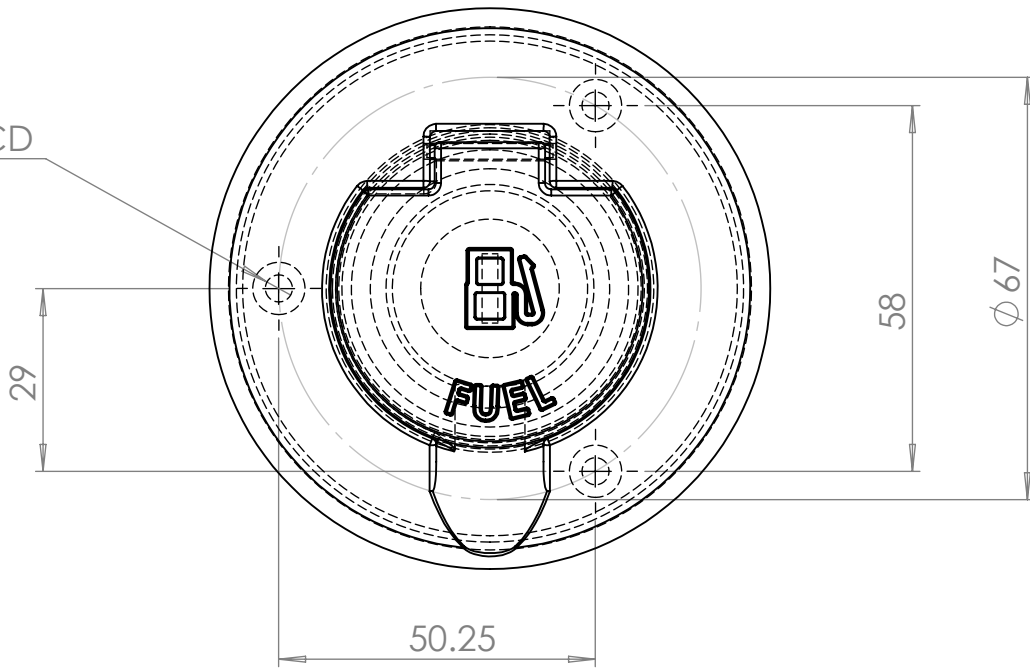

Product Name: FUEL FILLER			
Firm Name & Address: Jay Wolfe Metalwork Ltd Unit 4 Horsley Road Northampton NN2 6LJ		Notes:	
Date:	Drawn By: S. Bird	Product Number: DFLCSSF50	