

ELECTRIC TOILETS STANDARD		COMMON SPARES	
SPARE VALID FOR MODELS			
6500000712	ELECTRIC TOILET COMPACT 12V, WOODEN SEAT	5500000000	9 GASKET KIT
5500000001	wooden seat compact	6000007005	10 DISCHARGE PORT CONNECTION
55000000712	kit conversion 12v	5500019010	10 FLUSH PUMP GROUP PLASTIC
6500000505	bowl compact	6000007121	5 MACERATOR GROUP
6500000724	ELECTRIC TOILET COMPACT 24V, WOODEN SEAT	GM000PK001	11 IMPELLER
6500000001	wooden seat compact	6000007007	13 DISCHARGE VALVE
5500000724	kit conversion 24 v	6000007105	10 DISCHARGE PORT CONNECTION 90°
6500000505	bowl compact	6000007100	4 PLASTIC BASE
6700000712	ELECTRIC TOILET COMPACT 12V,SOFT CLOSE S.	6500000551	3 intake elbow
6500000002	soft close seat compact	6000000712	7 ELECTRIC MOTOR 12V.
55000000712	kit conversion 12v	6000000724	7 ELECTRIC MOTOR 24V.
6500000505	bowl compact		
6700000724	ELECTRIC TOILET COMPACT 24V, SOFT CLOSE S		
6500000002	soft close seat compact		
5500000724	kit conversion 24 v		
6500000505	bowl compact		
6500000812	ELECTRIC TOILET COMFORT 12V,SOFT CLOSE S.		
6500000004	soft close seat comfort		
5500000712	kit conversion 12v		
6500000509	bowl comfort		
6500000824	ELECTRIC TOILET COMFORT 24V,SOFT CLOSE S		
6500000004	soft close seat comfort		
5500000724	kit conversion 24 v		
6500000509	bowl comfort		
6500000412	ELECTRIC TOILET space saver 12V,SOFT CLOSE S		
6500000002	soft close seat compact		
5500000712	kit conversion 12v		
6500000503	bowl space saver		
6500000424	ELECTRIC TOILET space saver 24V,SOFT CLOSE S		
6500000002	soft close seat compact		
5500000724	kit conversion 24 v		
6500000503	bowl space saver		

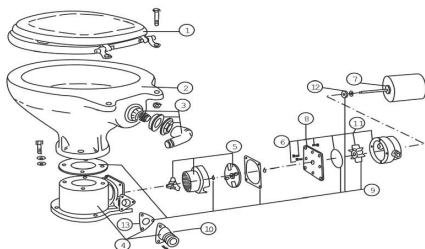

ELECTRIC TOILET COMPACT 12V, EVOLUTION		COMMON SPARES	
6400000712	ELECTRIC TOILET COMPACT 12V, EVOLUTION	5600000405	4 BASE GROUP
6500000002	soft close seat compact	6000056112.1	5 MOTOR GROUP 12V.
5600000112	kit conversion 12v	6000056124.1	5 MOTOR GROUP 24V.
6500000505	bowl compact	5600000407	6 OUTLET ELBOW
6400000724	ELECTRIC TOILET COMPACT 24V, EVOLUTION	6500000553	3 intake elbow 90°
6500000002	soft close seat compact	5600000110	8 FLUSH PUMP GROUP PLASTIC
5600000124	kit conversion 24 v	5600000100	8 GASKET KIT
6500000505	bowl compact		
6400000812	ELECTRIC TOILET COMFORT 12V, EVOLUTION		
6500000004	soft close seat comfort		
5600000112	kit conversion 12v		
6500000509	bowl comfort		
6400000824	ELECTRIC TOILET COMFORT 24V, EVOLUTION		
6500000004	soft close seat comfort		
5600000124	kit conversion 24 v		
6500000509	bowl comfort		

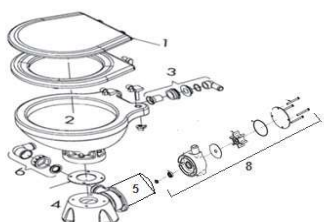

ELECTRIC TOILET STANDARD Laguna		COMMON SPARES	
SPARE VALID FOR MODELS			
6500200912	ELECTRIC TOILET LAGUNA 12V, Soft c, SEAT	5500019008	A PLASTIC BASE LAGUNA AND DELUXE STD/LOW
6500000002	soft close seat compact	5500019010	C FLUSH PUMP GROUP PLASTIC for laguna version
5500019112	kit conversion std laguna 12v	5500030810	C FLUSH PUMP GROUP PLASTIC for luxury version
6500000512	bowl laguna	6000019112	B ELECTRIC MOTOR 12V, LAGUNA AND DELUXE STD/LOW
6500200924	ELECTRIC TOILET LAGUNA 24V, Soft c, SEAT	6000019112	B ELECTRIC MOTOR 24V, LAGUNA AND DELUXE STD/LOW
6500000002	soft close seat compact	GM000PK001	IMPPELLER
5500019124	kit conversion std laguna 24 v	5500019006	D OUTLET ELBOW LAGUNA AND DELUXE STD/LOW
6500000512	bowl laguna	6500000551	D intake elbow laguna/deluxe/luxury
6500002412	ELECTRIC TOILET 12V, "Luxury" LOW		
6500000007	SEAT FOR LUXURY SOFT CLOSE		
6500000545	NEW LUXURY TOILET BOWL LOW		
5500003812	DELUXE HYDRO-VACUUM KIT 12V.		
6500002424	ELECTRIC TOILET 24V, "Luxury" LOW		
6500000007	SEAT FOR LUXURY SOFT CLOSE		
6500000545	NEW LUXURY TOILET BOWL LOW		
5500003824	DELUXE HYDRO-VACUUM KIT 24 V.		
6500002612	ELECTRIC TOILET 12V, "Luxury" STD		
6500000007	SEAT FOR LUXURY SOFT CLOSE		
6500000547	NEW LUXURY TOILET BOWL STD		
5500003812	DELUXE HYDRO-VACUUM KIT 12V.		
6500002624	ELECTRIC TOILET 24V, "Luxury" STD		
6500000007	SEAT FOR LUXURY SOFT CLOSE		
6500000547	NEW LUXURY TOILET BOWL STD		
5500003824	DELUXE HYDRO-VACUUM KIT 24 V.		

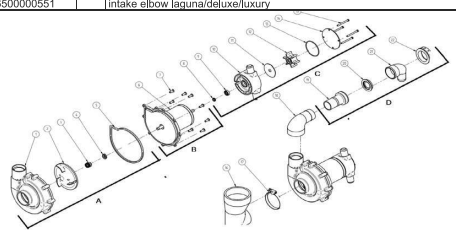

Electric toilets

Features: • Silent Flush and discharge operation • Included control panel for rinse and discharge pump
 • Flexible hole pattern on the base, for easy substitution with the most common toilets on the market • Smooth design for easy cleaning • Accessible mounting points for fast installation • Standard fastenings, logic located, no need for special tools • High capacity discharge pump • Built in rinse pump. For raw water or fresh water from separate toilet water tank. Do not connect the toilets rinse pump to the boat tank

MOUNTING: Before starting the assembly, read the complete mounting instruction first. You need: Stainless steel bolts: 4 pcs, 8mm (5/16") diameter of length to suit the thickness of the mounting surface. Stainless steel nuts: 4 pcs preferably self-locking. If you do not use self-locking nuts you need to add locking compound on the screws-/ nuts. Stainless steel washers: 4 pcs. • Drill: Diameter 9mm. • Silicone sealant, white. • If you do not use self-locking nuts, you will need some nutlocking compound. Put the toilet in the selected position. Using the holes in the base as a guide, mark the positions for the 4 bolt holes on the mounting surface. Remove the toilet and drill 4 vertical holes, with a diameter of 9mm, through the mounting surface. Apply the white silicone sealant to the outer rim of the bottom base. Put the toilets on its place and tighten the fastenings securely. If you are not using self-locking nuts, use nutlocking compound. Use the sealant around the base, towards the floor.

OPERATING INSTRUCTIONS

The toilet is one of the most used pieces of equipment on your boat. Correct operation of the toilet is essential for the safety and comfort of your crew and craft. Using the toilet: Control panel The panel controls the rinse and the discharge, by one button. Button 1, One function, discharge and rinse. • Normal Use: Ensure that the inlet and outlet valves are open: 1. Push the button switch to operate flush until the bowl is thoroughly 2. rinse and the discharge pump has ejected the water from the base of the bowl. If the toilet has not been used for a while, and the bowl is dry, it's recommended to operate the pumps for a few seconds so the bowl gets wet. This is for preventing the toilet paper to become compact at the bottom of the bowl. The toilet can macerate organic waste and toilet paper, but it can not destroy rugs, sanitary nappies or hard and solid objects from different nature. If the pump does not discharge and the bowl begins to fill, partially close the toilet intake valve until the bowl is completely empty. Operate that for a few seconds with both valves open, so that the toilet and the whole discharge system may be completely emptied out. After each operation, close both inlet and discharge valves. • To drain for winterization, close the inlet valve and operate for a few seconds until water is completely empty. AFTER USE: • SHUT BOTH SEACOCKS NOTE: Do not put any of the following into the toilet: Sanitary Towels, Wet Strength Tissues, Cotton Wool, Cigarettes, Matches, Chewing Gum or any solid objects, Petrol, Diesel, Oil, Solvents of any kind or water more than hand warm. A rule of thumb: Do not put anything in the toilet unless it has passed through your body, except for toilet paper. Hazard Risk: ACCIDENTAL DAMAGE. If the toilet is connected to ANY through-hull fittings that are below the waterline at any time, and if the toilet or pipework is damaged, water may flood in, causing the craft to sink, which may result in loss of life. Therefore, after every usage; both seacocks (or secondary valves) MUST be shut. Whenever your craft is unattended, even if only for a very short period of time, both seacocks (even if secondary valves are fitted) MUST be shut. Ensure that ALL users understand how to operate the toilet system correctly and safely, including seacocks and secondary valves. Take special care to instruct children, the elderly and visitors. ABSOLUTELY SHUT SEACOCKS!. Cleaning A regular flushing with clean (sea-)water represents one of the most effective methods to keep the toilet clean and good smelling. To clean the bowl, use any liquid or cream ceramic cleaner. • To clean the rest of the toilet, including the seat and lid, use a non-abrasive liquid cleaner Polish with a dry cloth only. To disinfect the toilet, use a liquid disinfectant diluted in accordance with the manufacturer's instructions. It is possible to apply it to all parts of the toilet using a sponge or soft brush as necessary. After applying any cleaning or disinfecting agent, always flush well. • DO NOT ALLOW THESE AGENTS TO STAND IN THE SYSTEM WATER CONNECTIONS FOR INSTALLATIONS ABOVE THE WATERLINE For a better functioning of the pump and to avoid water contamination, the fitting of a non-return valve at the end of the hose, next to the tank or the through-hull device is suggested. Connect the toilet inlet terminal to the water supply with a flexible hose of 19 mm. Connect the discharge terminal to a waste tank or another discharge system with a flexible hose of 1". To retain some water in the bowl, make a siphon on the discharge hose, at 20 cm. above the base of the bowl. Be sure that all connection are airtight and that the hose has no chokes or narrow bends. WATER CONNECTIONS FOR INSTALLATIONS BELOW THE WATERLINE: Disconnect the hose between the pump and the bowl. Replace it with another hose of suitable length that can make a siphon at 20 cm. above the water line. The same procedure is required for the discharge line, taking also into account the eventual variations and trim adjustments that can happen during navigation. Connect the water supply to the inlet terminal with a flexible hose of 19 mm. and connect the discharge terminal to a flexible hose of 1". Make sure that all connections are airtight and that the hose is showing no chokes or narrow bends.

ELECTRIC CONNECTIONS:

For a better functioning of the toilet, the connections have to be made with the correct size wires (see the table below). The circuit for the toilet power supply has to be independent and cannot be used for another appliances. Connect the battery positive terminal to a fuse of adequate capacity load. The fuse has to be connected near the battery to shelter the feeding line in case of fault. Thus, connect the fuse to one terminal of the switch control panel. The other switch control terminal has to be connected to the positive red colour wire of the toilet motor. Connect the negative black wire of the toilet motor to the negative terminal of the battery. REMARKS : A correct motor polarity (red to positive and black to negative) is indispensable. Reverse polarity can damage the motor, thus voiding the warranty. For a correct functioning of the toilet a full voltage to the motor is necessary. Panel Red (upper wire on switch) to positive (+) battery via one fuse Panel Red (lower wire on switch) to toilet pump red Toilet pump Black to battery negative (-) To install the switch panel, use the template or dimensions from the template. Also, drill four appropriate sized holes for the fasteners selected to secure the switch panel to its mounting surface. Use the enclosed template, see next page.

IMPORTANTE: LE ISTRUZIONI DI MONTAGGIO SARANNO PRESTO DISPONIBILI IN ITALIANO: WWW.MATROMARINE.COM/OUR-PRODUCTS

IMPORTANT: LES INSTRUCTIONS DE MONTAGE SERONT DISPONIBLES BIENTOT AUSSI EN FRANCAIS: WWW.MATROMARINE.COM/OUR-PRODUCTS

IA INSTRUIONES PARA E MONTAJES ESTARAN LISTAS EN LA MAS BREVIDAD POSIBLE EN ESPANOL : WWW.MATROMARINE.COM/OUR-PRODUCTS

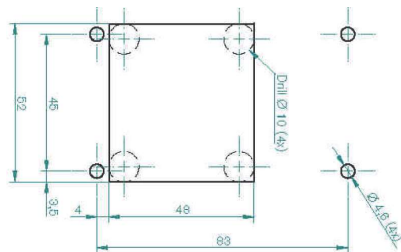
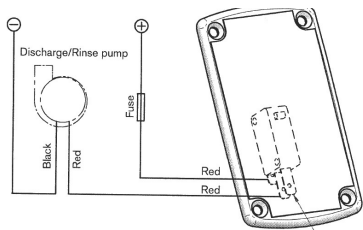

VERY IMPORTANT:

Wire size per feet and meter of run

Voltage	Fuse size	Wire size per feet and meter of run				
		0'-10'	10'-15'	15'-25'	25'-40'	40'-60'
12V	25A	0m-3m	3m-4,6m	4,6m-7,6m	7,6m-12,2m	12,2m-18,3m
		#14	#14	#12	#10	#8
24V	20A	2,5 mm ²	2,5 mm ²	4 mm ²	6 mm ²	10 mm ²
		#14	#14	#14	#14	#12
24V	20A	2,5 mm ²	2,5 mm ²	2,5 mm ²	2,5 mm ²	4 mm ²
		#14	#14	#14	#14	#12

Description	A	B	C	D	E
Std. electric compact, 12V	345	692	373	209	216
Std. electric compact, 24V	386	747	380	220	275

Space saver 300mm high

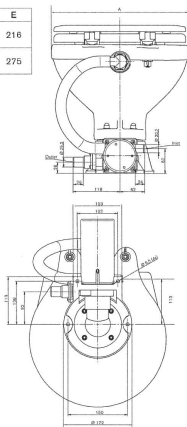
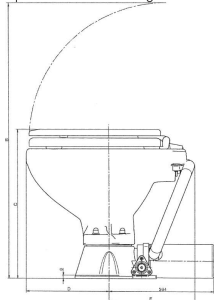

Description	A	B	C	D	E	F
Laguna electric 12v.	340	411	359	248	316	190/205

Luxury Standard: 365x455x455h
Luxury Low: 365x455x385h

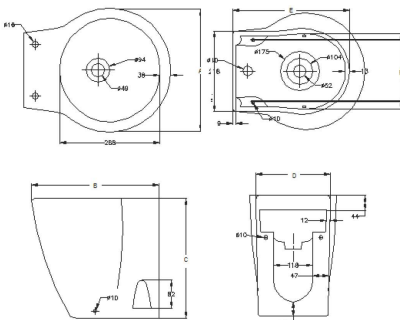

Cleaning:

A regular flushing with clean (sea)-water represents one of the most effective methods to keep the toilet clean and good smelling. • To clean the bowl, use any liquid or cream ceramic cleaner • To clean the rest of the toilet, including the seat and lid, use a non-abrasive liquid cleaner Polish with a dry cloth only. • To disinfect the toilet, use a liquid disinfectant diluted in accordance with the manufacturer's instructions. It is possible to apply it to all parts of the toilet using a sponge or soft brush as necessary. • After applying any cleaning or disinfecting agent, always flush well. **DO NOT ALLOW THESE AGENTS TO STAND IN THE SYSTEM**

Warranty:

Products are guaranteed two years. No warranty will be recognized in the following cases: if the bowl is broken if the fitted instructions regarding the electrical system and the directions for use have not been properly followed **Warning:** the use of strong detergents to clean the toilet is forbidden, as these products stay on the inside of the system and burn the pump rubber seals through. **Eventual traces found in the claimed goods will invalidate the warranty.** **TO TAKE ADVANTAGE OF WARRANTY, ALL ARTICLES MUST BE SENT BACK COMPLETE WITH ASSEMBLING INSTRUCTIONS AND EVIDENCE OF PURCHASE.**

CAUTION: Safety advice:



AVVISO: PERICOLO DI ALLAGAMENTO Se la toilette è installata al di sotto della linea di galleggiamento, o può trovarsi in qualsiasi momento sotto il livello dell'acqua a causa di inclinazione o beccheggio, occorre installare dei sifoni appositamente posizionati. La non osservanza di questa importante norma potrebbe provocare l'allagamento della barca, e causare la perdita della proprietà e della vita. **ATTENZIONE:** non collegare la toilette all'approvvigionamento di acqua potabile dell'imbarcazione. Questo potrebbe causare la contaminazione dell'acqua potabile. Nel caso in cui si desideri adoperare acqua dolce per il risciacquo della tazza provvedere un serbatoio separato per l'acqua dolce per convogliare l'acqua esclusivamente al WC.

WARNING: FLOOD HAZARD If the toilet is installed below the waterline, or may be below the water level at any moment because of heeling or pitching, it must be fitted with properly positioned vented-loops. Failure to do so can result in flooding, which may cause loss of property and life **CAUTION:** never connect the toilet to the vessel's potable water, to avoid any risk of potable water contamination. If fresh water is preferred for flushing the bowl, provide a separate fresh water tank to supply water to the toilet only.

AVERTISSEMENT: DANGER D'INONDATION Au cas où la toilette serait installée au dessous de la ligne de flottaison, ou pourrait se trouver au dessous du niveau de l'eau à n'importe quel moment ensuite à inclination ou tangage, il faut la munir de boucles ventilées positionnées d'une manière adéquate. Si cette importante instruction n'est pas respectée il y a le risque d'inondation, qui peut causer perte de la propriété et de la vie. **ATTENTION:** ne reliez jamais la toilette à l'approvisionnement de l'eau potable du bateau, pour éviter tout risque de contamination. Si on préfère de l'eau douce pour le rinçage de la cuvette, il est nécessaire de pourvoir un réservoir séparé pour l'eau douce et canaliser l'eau exclusivement à la toilette. **WARNUNG: UEBERSCHWEMMUNGSGEFAHR** Wenn die Toilette unterhalb der Wasserlinie installiert ist, oder sich jederzeit unter dem Wasserspiegel wegen Neigung oder Stampfen befinden kann, ist es nötig dazu geeignete und angemessen positionierte Schwannenhalsventile zu montieren. Die Nichtbefolgung dieser sehr wichtigen Anweisung kann die Überschwemmung des Bootes verursachen und den Verlust des Eigentums und des Lebens als Folge haben. **VORSICHT:** Schließen Sie nie die Toilette an die Trinkwasserleitung an, denn das könnte zu der Verseuchung des Trinkwassers bringen. Falls Sie Süßwasser zur Schüsselspülung lieber haben, dann sorgen Sie für einen getrennten Trinkwasserspeicher woraus das Wasser nur an die Toilette geleitet werden kann.

AVISO: PELIGRO DE ALAGAMIENTO: Si el inodoro es instalado al debajo del nivel de flotamiento o se puede encontrar en cualquier momento al debajo del nivel del agua a causa de la inclinación o de la ondulación del barco a esto ocurre instalar los sifones en la posición correcta. Sino se observa esta regla importante esto puede provocar el allagamiento de la nave y la pérdida de la vida. **ATTENCIÓN:** No conectar el inodoro a la fuente del agua potable de la nave. Esto puede causar la contaminación del agua potable de enel caso de colear el agua dulce para el enjuague del inodoro se necesita instalar un contenedor del agua dulce, separado para mandar el agua directamente al inodoro.

Le toilette elettriche possono essere installate sopra o sotto la linea di galleggiamento. L'altezza massima di auto-ascendimento e' di un 1,2 m. L'altezza massima di reflouement est de 1,2 m. **Electric toilets can be installed above or below the sea level.** Maximum self-priming height is 1,2 m. Maximum discharge height is 1,2 m.

Les toilettes peuvent tre install es au-dessus ou au-dessous de la ligne de flottaison. La hauteur d'amorçage maximale est de 1,2 m. La hauteur maximale de refoulement est de 1,2 m. **Los inodoros lectricos pueden instalarse por encima o por debajo de la linea de flotacion.** Lamáxima altura de autocébedo es de 1.2 m., y la máxíma altura de descarga es de 1.2 m.

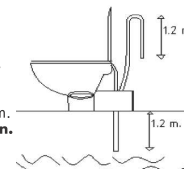

Toilette sopra la linea di galleggiamento:

1. Presa d'acqua dal mare da 19 mm.
2. Valvola di ritegno d'immissione
3. Rialzo di 20 cm. sopra la base per trattenerne l'acqua nella tazza
4. Presa d'acqua dal mare da 38 mm.

Toilet above the waterline

1. 19 mm. sea-cock 2. Inlet non-return valve 3. 20 cm. rise above the base to retain water in the toilet bowl 4. 38 mm. sea-cock

Toilette au-dessus de la ligne de flottaison

1. Passe-coque de 19 mm.
2. Clapet anti-retour
3. Soulèvement de 20 cm. au-dessus de la base pour maintenir l'eau à l'intérieur de la cuvette
4. Passe-coque de 38 mm.

Inodoro por encima de la linea de flotacion

1. Grifo al mar de 19 mm.
2. Válvula unidireccional de entrada
3. Organizar la manguera de salida de, por lo menos 20 cm por encima de la flotación o holdingtank 4. Seacock dulce de retención .

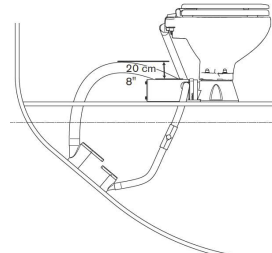

Toilette al disotto della linea di galleggiamento:

1. Presa d'acqua dal mare da 25 mm. o 38 mm.
2. Almeno 20 cm
3. Anello di 25 mm. o 38 mm. con apertura di ventilazione
4. Presa d'acqua dal mare da 19 mm.
5. Anello di 19 mm. con apertura di ventilazione con elettrovalvola
6. Linea di galleggiamento durante l'inclinazione

Toilet below the waterline

1. 25 mm. or 38 mm. sea-cock 2. At least 20 cm.
3. 25 mm. or 38 mm. vented loop
4. 19 mm. sea-cock 5. 19 mm. vented loop complete of solenoid valve
6. Heeled waterline

Toilette au dessous de la ligne de flottaison

1. Passe-coque de 25 mm. ou de 38 mm.
2. 20 cm. Minimum
3. Boucle ventilée de 25 mm. ou de 38 mm
4. Passe-coque de 19mm.
5. Boucle ventilée de 19 mm. complète de soupape électronique
6. Ligne de flottaison maximale

Inodoro por debajo de la linea de flotacion

1. Grifo al mar de 25 ó 38 mm.
2. Por lo menos 20 cm.
3. Vuelta ventilada de 25 ó 38 mm.
4. Grifo al mar de 19 mm
5. Vuelta ventilada de 19 mm. con válvula solenoide
6. la linea de flotación.

